



RO **Schelă mobilă (platformă de lucru mobilă) ProTec® XXL**
Manual de montare și utilizare

Schelă mobilă (platformă de lucru mobilă) ProTec® XXL
EN 1298-IM-ro • EN 1004 3 8/12 XXXD •
Schelă mobilă (platformă de lucru mobilă) conform DIN EN 1004-1



RO Cuprins

1. Generalități.....	82
1.1 Responsabilitatea operatorului	82
1.2 Producător	82
1.3 Standarde aplicabile, aprobare de model	82
1.4 Garanție.....	82
1.5 Drepturi de autor și drepturi conexe	83
1.6 Data emiterii	83
2. Informații referitoare la produs.....	83
2.1 Utilizare conformă cu destinația	83
2.2 Utilizare neconformă cu destinația	83
3. Reglementări de siguranță.....	84
3.1 Reglementări valabile	84
3.2 Reglementări de siguranță pentru montare și utilizare.....	84
3.3 Reglementări de siguranță la deplasarea platformei de lucru mobile	84
3.4 Verificarea locului de utilizare înainte de montare, după deplasare sau reconstrucția schelei mobile (platformei de lucru mobile)	85
3.5 Unele necesare.....	85
4. Montare	85
4.1 Generalități	85
4.2 Montarea setului de stabilizare	85
4.3 Încărcarea cu balast a schelei mobile (platformei de lucru mobile)	86
4.4 După montarea sau modificarea schelei mobile (platformei de lucru mobile)	86
5. Demontarea platformei de lucru mobile.....	86
6. Verificare, îngrijire și întreținere	86
7. Prezentare generală a modelului	105
8. Componente	109
9. Liste de piese	111
10. Zone de adunare	113
11. Etape de lucru (tabel)	114
12. Desene de suprastructură ale diferitelor schele	116
13. Detalii privind balastarea	133
14. Accesorii.....	135

1. Generalități

Acest manual de utilizare descrie montarea și demontarea, precum și utilizarea schelei mobile (platformei de lucru mobile) ProTec. Citiți cu atenție manualul de utilizare înainte de utilizare și familiarizați-vă cu reglementările de siguranță. Schela mobilă (platforma de lucru mobilă) trebuie montată, modificată și demontată doar de angajați adecvați profesional.

Ne rezervăm dreptul de a efectua modificări tehnice la schela mobilă (platforma de lucru mobilă). Nu ne asumăm răspunderea pentru erori de tipar ale acestui manual de montare și utilizare.

1.1 Responsabilitatea operatorului

Operatorul schelei mobile (platformei de lucru mobile) trebuie să se asigure, pe proprie răspundere, că

- acest manual de montare și utilizare este disponibil la locul utilizării.
- această schelă mobilă (platformă de lucru mobilă) este folosită doar conform acestui manual de montare și utilizare, fără orice modificare.
- schela mobilă (platforma de lucru mobilă) este adecvată pentru lucrările care trebuie efectuate.
- personalul operatorului este informat cu privire la instrucțiunile de siguranță și avertizările din acest manual privind pericolele și că instrucțiunile și prevederile sunt urmate.
- dispozițiile naționale, regionale și locale pentru operarea schelei mobile (platformei de lucru mobile) sunt respectate.
- instructajele privind utilizarea nu sunt o înlocuire a manualului de montare și utilizare și acestea doar îl completează.
- în unele țări poate fi obligatoriu un instructaj.
- schela mobilă (platforma de lucru mobilă) este folosită doar conform destinației.

1.2 Producător

Producătorul schelei mobile (platformei de lucru mobile) descrise în prezenta documentației este firma:

KRAUSE-Werk GmbH & Co. KG
Am Kreuzweg 3
D 36304 Alsfeld
Telefon: +49 (0) 6631 795-0
Telefax: +49 (0) 6631 795-139
www.krause-systems.com



1.3 Standarde aplicabile, aprobare de model

Schela mobilă (platforma de lucru mobilă) din seria ProTec este conformă cu DIN EN 1004-1. Stabilitatea schelei mobile (platformei de lucru mobile) și dimensionarea componentelor sunt dovedite pe baza unui calcul static. Recepția tehnică se face de către TÜV-Süd PRODUKT SERVICE (aprobarea de model).

1.4 Garanție

Textul exact al garanției este stabilit în condițiile de vânzare și livrare ale furnizorului. Producătorul preia o garanție de 5 ani de la data vânzării piesei respective, pentru defecte de material. Producătorul își rezervă dreptul de a înlocuire sau de a repara piesa defectă, la libera sa alegere.

Pentru drepturi de garanție care rezultă din documentație este decisiv manualul de montare și utilizare valabil la data vânzării. Un drept de garanție este exclus dacă daunele au luat naștere dintr-unul sau mai multe dintre motivele următoare:

- Necunoașterea sau nerespectarea manualului de montare și utilizare, mai ales a instrucțiunilor de siguranță, a instrucțiunilor privind utilizarea conformă și neconformă cu destinația, a instrucțiunilor privind întreținerea și repararea, a instrucțiunilor de montare și demontare.
- În cazul în care personalul operatorului este insuficient calificat sau insuficient informat.
- La utilizarea de piese de schimb și/sau accesorii care nu sunt originale.
- La utilizarea de componente deteriorate sau defectuoase.
- O creștere a înălțimii de lucru prin utilizarea de scări, lăzi sau ale echipamente.

1.5 Drepturi de autor și drepturi conexe

Producătorul are toate drepturile asupra manualului de montare și utilizare. Orice tip de multiplicare, chiar și în extras, este admisă doar cu aprobarea producătorului. Producătorul își rezervă toate drepturile privind acordarea de brevete și înregistrarea de modele de utilitate. Încălcările obligă la plata de despăgubiri!

1.6 Data emiterii

Data emiterii prezentului manual de montare și utilizare este 01.11.2021.

2. Informații referitoare la produs

2.1 Utilizare conformă cu destinația

Utilizarea schelelor mobile (platformelor de lucru mobile) menționate în prezentul manual de montare și utilizare este permisă doar conform prevederilor DIN EN 1004-1 și sumarului modelului menționat la punctul 7.

Schela mobilă (platforma de lucru mobilă) din seria ProTec corespunde clasei de încărcare 3 (suprafața platformei 200 kg/m²).



AVERTIZARE cu privire la supraîncărcarea schelei mobile (platformei de lucru mobile).
cu privire la prăbușirea schelei mobile (platformei de lucru mobile), sunt posibile
accidentări grave sau mortale.

Încărcare maximă:

- Nivel de lucru 2,00 m × 1,20 m 480 kg; 3 persoană
- Forță orizontală maximă în cazul platformelor: 30 kg
- Este permis întotdeauna lucrul doar pe o singură platformă.
- Urcarea este permisă doar din interior.
- Înălțimea este de 12,00 m în spații închise pe toate părțile și se 8,00 m în aer liber.
- Este permisă amplasarea schelei mobile (platformei de lucru mobile) doar pe o suprafață suport suficient de portantă și plană.
- Alinierea trebuie verificată cu o nivelă, în direcție verticală și orizontală. Înclinarea maxim admisă este de 1 %. Schelele mobile (platformele de lucru mobile) fără reglare a înălțimii trebuie alinate cu material rezistent la rupere și anti-alunecare.
- Înainte de utilizarea trebuie asigurat faptul că au fost luate toate măsurile de siguranță necesare și că schela mobilă (platforma de lucru mobilă) a fost montată corespunzător, conform manualului de montare și utilizare.
- Dacă este cazul, schela mobilă (platforma de lucru mobilă) trebuie asigurată împotriva răsturnării cu balast și/sau cu consolă. Respectați tabelele privind balastul, de la paginile 133–134.

2.2 Utilizare neconformă cu destinația

Este permisă folosirea schelei mobile (platformei de lucru mobile) doar pentru utilizarea conform destinației menționată la 2.1. O abatere de la aceasta este considerată ca utilizare neconformă cu destinația. Neconformă cu destinația este, printre altele:

- Montarea de treceri între schela mobilă (platforma de lucru mobilă) și o clădire sau o altă construcție.
- Legarea mai multor schele mobile (platforme de lucru mobile) pentru a forma o schelă de suprafață, spațiu sau portantă.
- Utilizarea ca turn de scară pentru urcarea pe alte platforme de lucru mobile.
- Montarea și utilizarea de echipamente de ridicare.
- Utilizarea schelei mobile (platformei de lucru mobile) ca punct de fixare pentru asigurarea personală împotriva căderii.
- Utilizarea ca protecție laterală, de ex. la margini de cădere.

3. Reglementări de siguranță

3.1 Reglementări valabile

Pentru montarea și demontarea, stabilitatea și utilizarea schelei mobile (platformei de lucru mobile) se aplică dispozițiile DIN EN1004-1 și DIN EN1298 (prEN 1004-2).

3.2 Reglementări de siguranță pentru montare și utilizare

- Montarea și demontarea precum și utilizarea este permisă doar persoanelor care sunt familiarizate cu prezentul manual.
- Pentru montare și demontare sunt necesare cel puțin 2 persoane.
- Înainte de montare, modificare sau demontare este necesară verificarea locului de amplasare cu privire la pericolele posibile. Aceste pericole trebuie înlăturate, evitate sau reduse la minim.
- Pericolele posibile pot fi provocate de: suprafață suport instabilă, pantă, obstacole, condiții meteorologice, pericole electrice, eventuale presiune dinamică crescută a vântului printr-un efect de tunel în clădiri deschise sau la colțuri de clădiri.
- Este permisă doar utilizarea de piese originale nedeteriorate ale schelei mobile (platformei de lucru mobile).
- Înainte de utilizare, rolele de rulare trebuie asigurate prin apăsarea pârghiilor de frână și toate componentele trebuie verificate cu privire la asamblare corectă și funcționalitate.
- Este permis întotdeauna lucrul doar pe un singur nivel al platformei. Acesta trebuie să prezinte o protecție laterală completă cu scânduri.
- O utilizare a schelei mobile (platformei de lucru mobile) este permisă doar până la o intensitate a vântului 6 (~ 45 km/h). Înainte de depășirea intensității vântului 6, schelele mobile (platforma de lucru mobilă) trebuie demontată sau deplasată într-o zonă protejată împotriva vântului și acolo trebuie asigurată împotriva răsturnării.
- Depășirea intensității vântului 6 poate fi recunoscută, de ex. printr-o rezistență perceptibilă la mers.
- Pentru platforme pe care se lucrează se va folosi o protecție laterală din 3 părți, formată din balustradă, bare intermediare și scânduri de jur-împrejur. În cazul planurilor intermediare care servesc doar pentru montare, demontare și reconstrucție, precum și pentru urcare, se poate renunța la scândurile de jur-împrejur.



- Montarea de prelate sau plase pe schelele mobile (platforma de lucru mobilă) este interzisă.
- Nu urcați pe partea exterioară a schelei mobile (platformei de lucru mobile).
- Ridicarea sau suspendarea schelei mobile (platformei de lucru mobile) este interzisă.
- Sarcini externe orizontale sau verticale pot duce la răsturnarea schelei mobile (platformei de lucru mobile).

- După finalizarea lucrărilor, schelele mobile (platforma de lucru mobilă) trebuie ancorată și asigurată împotriva utilizării neautorizate, resp. trebuie demontată.
- Traversele și balastul, precum și consolele și seturile de stabilizare trebuie montate corespunzător prezentului manual de montare și utilizare.
- Uneltele și materialele pot fi transportate doar în sus.
- La platforme cu înălțime liberă de peste un metru accesarea și părăsirea platformei este permisă doar prin trapă.
- Legarea schelei mobile (platformei de lucru mobile) cu clădiri prin scânduri sau alte materiale asemănătoare este nepermisă.
- Nu este permisă utilizarea schelei mobile (platformei de lucru mobile) ca turn de urcare pentru a ajunge pe alte construcții.

3.3 Reglementări de siguranță la deplasarea platformei de lucru mobile

La deplasare nu este permis ca pe schelele mobile (platforma de lucru mobilă) să se afle vreun material sau vreun persoană.

- Este permisă deplasarea schelei mobile (platformei de lucru mobile) doar manual și doar pe o suprafață de amplasare solidă, plană și fără obstacole.
- Este interzisă deplasarea schelei mobile (platformei de lucru mobile) prin apelarea la ajutorul altor vehicule.

- La deplasare nu trebuie depășită viteza normală la pas.
- Deplasarea este permisă doar în direcție longitudinală sau diagonală.
- Suprafața pe care are loc deplasarea trebuie să poată prelua greutatea platformei de lucru mobile.
- Ridicarea sau suspendarea schelei mobile (platformei de lucru mobile) este interzisă.
- Deplasarea schelei mobile (platformei de lucru mobile) este permisă doar până la o intensitate a vântului 6 (~ 45 km/h).
- Înainte de urcare trebuie blocate rolele de rulare.

3.4 Verificarea locului de utilizare înainte de montare, după deplasare sau reconstrucția schelei mobile (platformei de lucru mobile)

Înainte de fiecare utilizare a schelei mobile (platformei de lucru mobile) trebuie verificate următoarele puncte:

- Schela mobilă (platforma de lucru mobilă) trebuie să stea vertical, dacă este cazul corecții poziția.
- Toate piesele sunt montate integral conform manualului de montare și utilizare.
- Balastul și consolele sunt montate corespunzător manualului de montare și utilizare.
- Blocați frânele de imobilizare ale roților de rulare după deplasare.
- Nu există niciun pericol electric.
- Niciun fel de modificări ale ambientului nu împiedică utilizarea în siguranță a schelei mobile (platformei de lucru mobile).

3.5 Unelte necesare

Nivelă



4. Montare ➔

4.1 Generalități

Montarea schelei mobile (platformei de lucru mobile) este permisă doar după ce au fost citite integral informații referitoare la produs (secțiunea 2) și reglementările de siguranță (secțiunea 3). Pentru montare și demontare sunt necesare cel puțin 2 persoane. Începând de la o înălțime de 6 m, pentru fiecare 2 m înălțime este necesară o persoană suplimentară. Este permisă folosirea doar de componente originale, conform indicațiilor producătorului.

Pe paginile 114 și 115 găsiți pașii de lucru individuali pentru montarea schelei în formă tabelară. Vă rugăm să țineți cont de faptul că pașii de lucru se pot repeta (și de mai multe ori). De aceea urmați exact pașii de lucru conform înălțimii schelei mobile, care sunt prezentați detaliat începând de la capitolul 12 „Pași de montaj“.

* Dacă cu pachete cu înălțime de lucru inegală (de ex. 7,30 m), doriți să realizați o înălțime de lucru egală, mai joasă (de ex. 6,30 m), aveți nevoie suplimentar de 2 buc. contrafișe diagonale, nr. art. 912879.

INSTRUCȚIUNI PRIVIND UTILIZAREA MANUALULUI DE MONTARE

Manualul de montare descrie montarea diverselor variante de montare ale sistemului ProTec. Înainte de montare, citiți întregul manual de montare și respectați diferențele între diversele variante de montare. În funcție de înălțimea de montare a platformei celei mai de sus, pentru creșterea stabilității sunt necesare balasturi (varianta **A** – pagina 127) sau console (varianta **B** – pagina 128). În acest scop, citiți instrucțiunile corespunzătoare din prezentul manual.

4.2 Montarea setului de stabilizare

La utilizarea la un perete, schela mobilă (platforma de lucru mobilă) cu setul de stabilizare poate împiedica răsturnarea spre perete. Utilizarea setului de stabilizare nu înlocuiește în niciun caz balastul și consolele prevăzute. Se vor monta cel puțin două bucăți direct sub platforma cea mai de sus (vezi desenul de la pagina 135). Pentru fixarea în perete se vor folosi șuruburi cu inel.

4.3 Încărcarea cu balast a schelei mobile (platformei de lucru mobile)

Schelele mobile (platformele de lucru mobile) trebuie să fie îngreunate cu balast la traverse, pentru a le asigura stabilitatea. Numărul greutateților depinde de înălțimea schelelor mobile (platformelor de lucru mobile) și poate fi luat din tabelele corespunzătoare începând de la pagina 133.

4.4 După montarea sau modificarea schelei mobile (platformei de lucru mobile)

Pe schela mobilă (platforma de lucru mobilă) trebuie amplasat un panou care să fie vizibil de la sol cu următoarele informații minime:

- numele și datele de contact ale persoanei responsabile
- dacă schela mobilă (platforma de lucru mobilă) este gata sau nu pentru a fi utilizată
- clasa de încărcare și greutatea totală maximă distribuită uniform
- dacă schela mobilă (platforma de lucru mobilă) este prevăzută doar pentru utilizarea în spații închise
- data montării

5. Demontarea platformei de lucru mobile

Schelele mobile (platformele de lucru mobile) trebuie demontate în ordinea inversă a descrierii montării corespunzătoare.

6. Verificare, îngrijire și întreținere

Înainte de montare, toate piesele trebuie verificate cu privire la deteriorări și trebuie înlocuite în caz de deteriorare. Doar producătorul are permisiunea de a efectua reparații ale pieselor. Este permisă doar folosirea de piese de schimb originale.

Printr-o inspecție vizuală trebuie asigurat faptul că îmbinările sudate și alte materiale nu prezintă fisuri. În plus, piesele nu trebuie să prezinte deformări și striviri. Se va acorda neapărat o atenție deosebită funcționării impecabile a componentelor precum blocări, fusuri, role de rulare etc.

Următoarele piese trebuie verificate înainte de fiecare montare:

- Cadru vertical, traversă: cu privire la deformare, strivire și formarea de fisuri
- Bare diagonale și de balustradă: cu privire la deformare, strivire și formarea de fisuri și funcția de siguranță
- Platforme: cu privire la deformare, strivire și formarea de fisuri și funcția de siguranță
- Trapă de urcare: cu privire la funcționare
- Scânduri: starea lemnului, fisuri
- Role de ghidare: capacitatea de rulare a rolei și funcționarea frânei pentru blocarea rulării și a rotirii.
- în cazul rolelor reglabile, ușurința de mișcare a fusului. Verificarea siguranței (pin de siguranță, șurub fluture) la cadrul vertical, resp. la traversă
- Șiguranțe împotriva desfacerii: cu privire la deformare, strivire, formarea de fisuri și poziția corectă.
- Piese trebuie să fie depozitate astfel încât să fie excluse deteriorări.
- Piese individuale trebuie să fie depozitate culcate și protejate împotriva intemperiilor.
- La transport, piesele trebuie așezate și asigurate astfel încât să fie evitate deteriorările.
- Curățarea pieselor se poate face cu apă și un detergent uzual. Petele de vopsea pot fi înlăturate cu terebentină.

7.

Art.-No. 945105

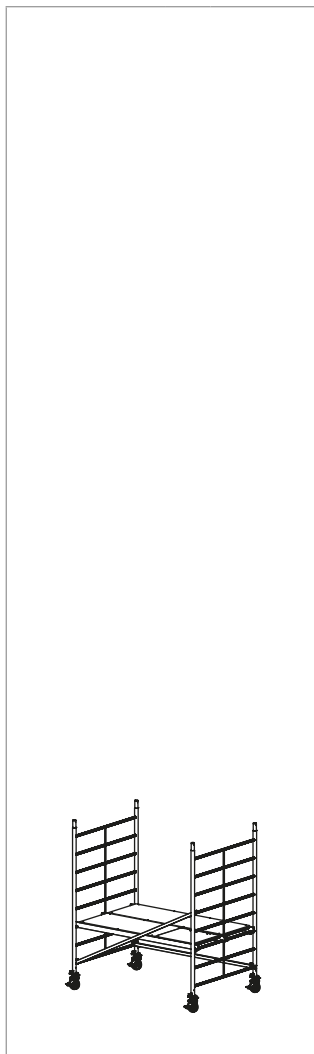

	A	2,90 m
	B	0,90 m
	C	2,35 m

Art.-No. 945112

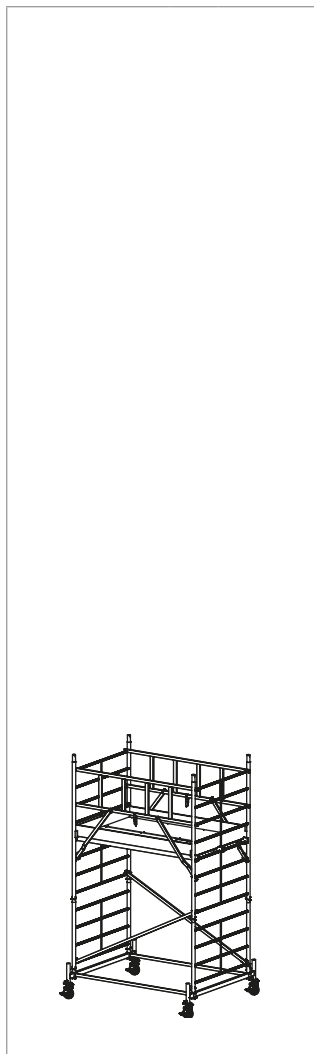

	A	4,30 m
	B	2,30 m
	C	3,45 m

Art.-No. 945129

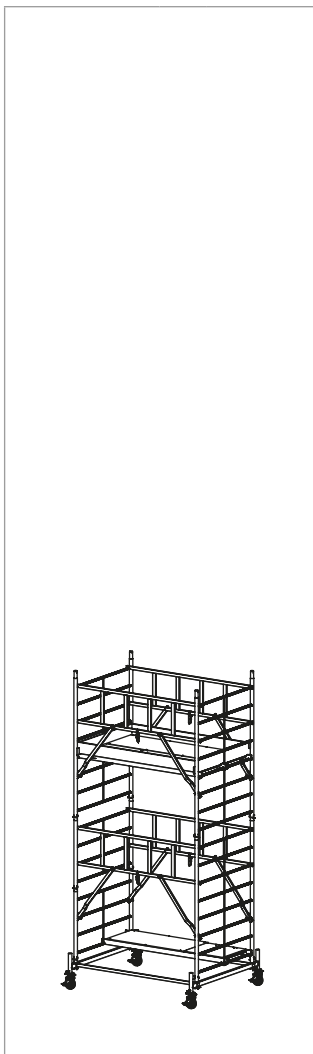

	A	5,30 m
	B	3,30 m
	C	4,45 m

Art.-No. 945136

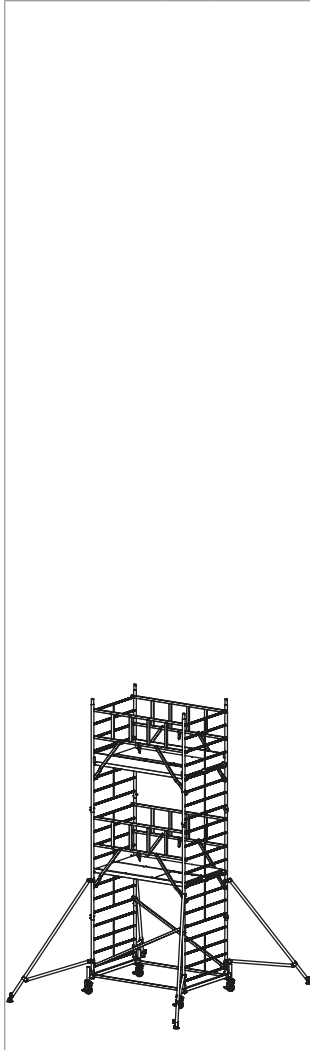

	A	6,30 m
	B	4,30 m
	C	5,45 m

Art.-No. 945143

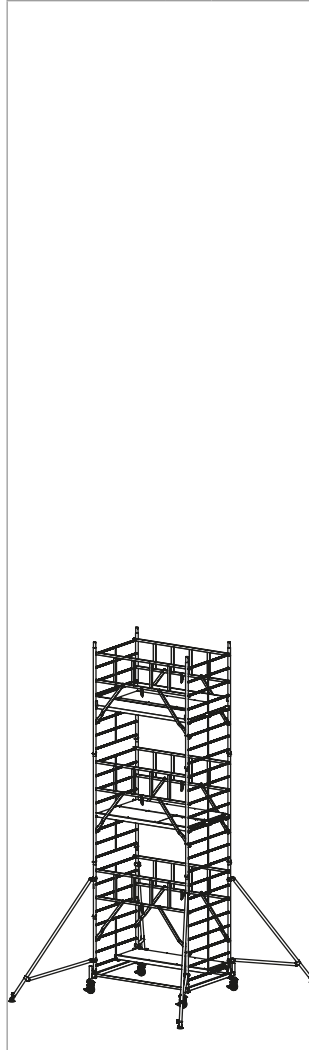

	A	7,30 m
	B	5,30 m
	C	6,45 m

Art.-No. 945150

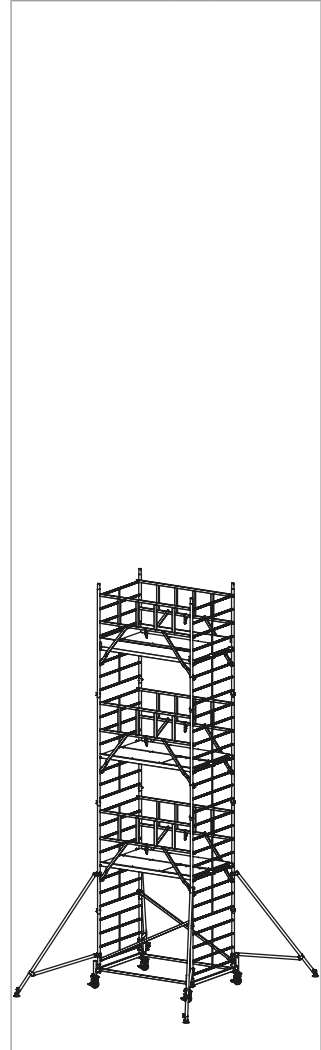

	A	8,30 m
	B	6,30 m
	C	7,45 m

Art.-No.

945167

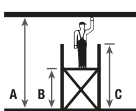
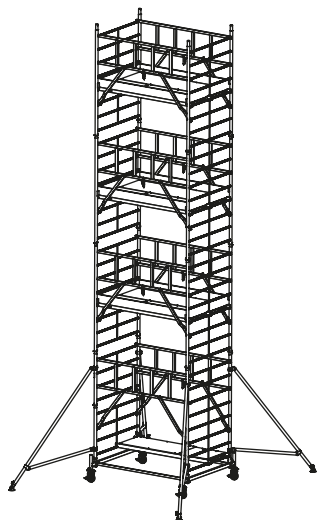

A	9,30 m
B	7,30 m
C	8,45 m

Art.-No.

945174

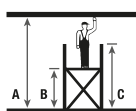
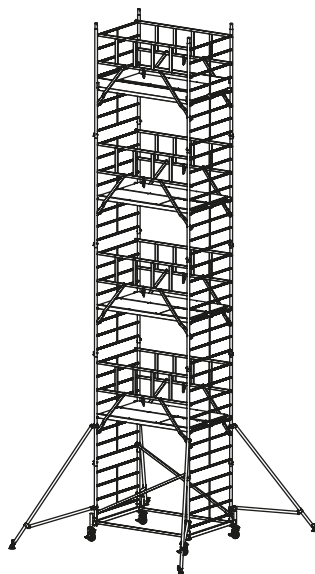

A	10,30 m
B	8,30 m
C	9,45 m

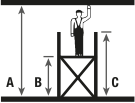
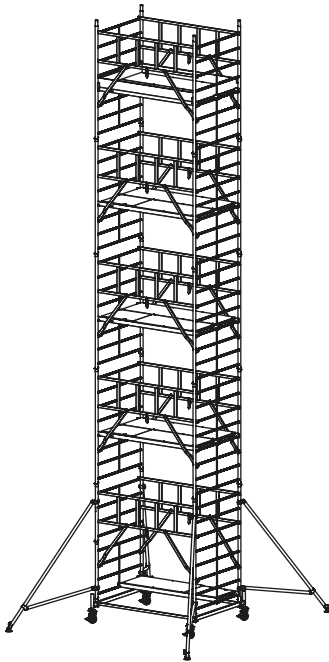



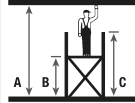
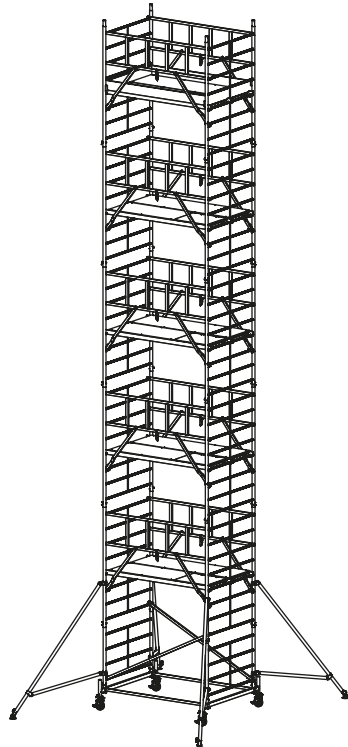



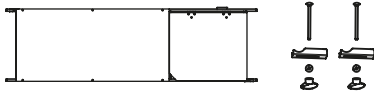
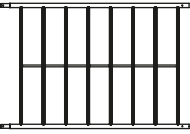
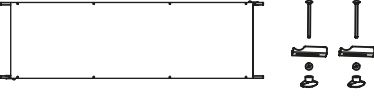
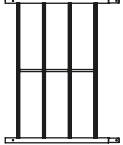

Art.-No.
945181

A	11,30 m
B	9,30 m
C	10,45 m

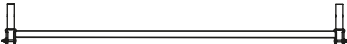
Art.-No.
945198

A	12,30 m
B	10,30 m
C	11,45 m

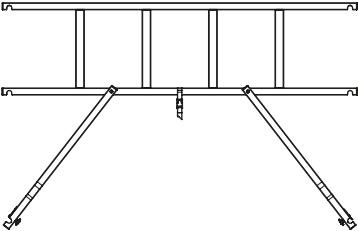
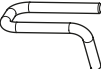





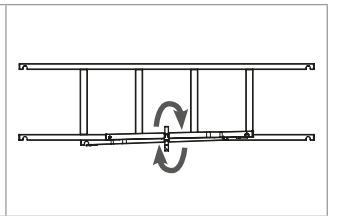
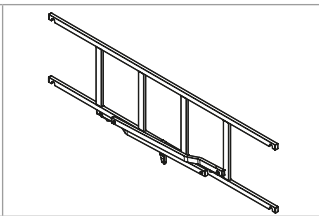
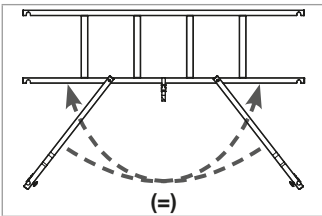
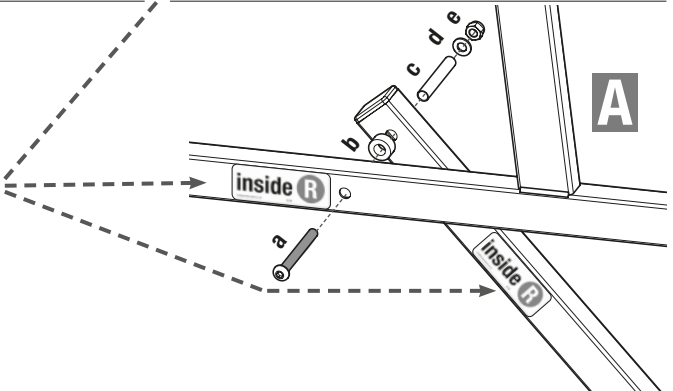
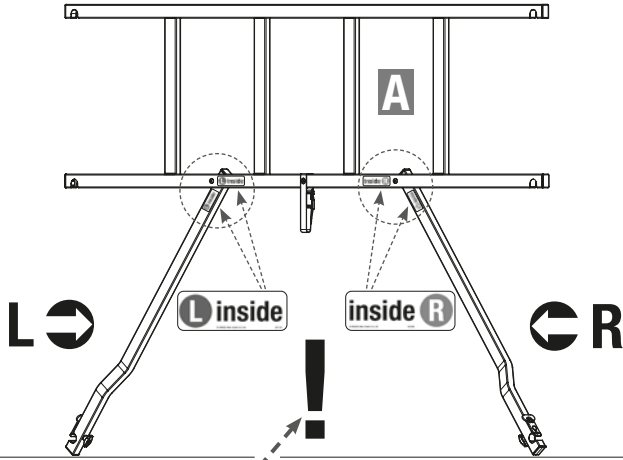
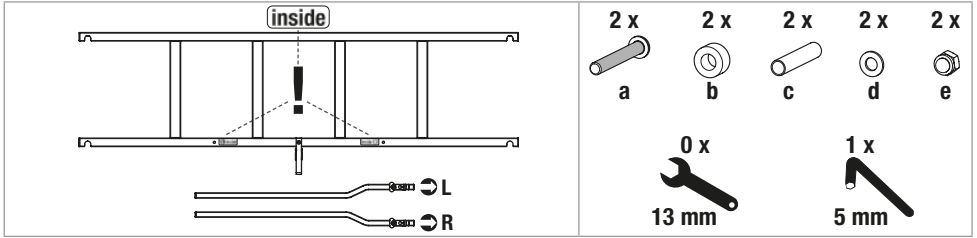



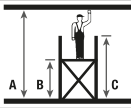

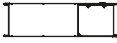
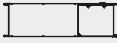

8.

	<p>Art.-No. 911001</p>		<p>Art.-No. 915078</p>
	<p>Art.-No. 911018</p>		<p>Art.-No. 915085</p>
	<p>Art.-No. 912879</p>		<p>Art.-No. 914071</p>
	<p>Art.-No. 912855</p>		<p>Art.-No. 913562</p>
	<p>Art.-No. 912848</p>		<p>Art.-No. 914118</p>
	<p>Art.-No. 913517</p>		<p>Art.-No. 914026</p>
	<p>Art.-No. 910073</p>		<p>Art.-No. 704405</p>
			<p>Art.-No. 914095</p>

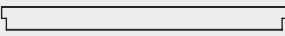
Art.-No. 910073

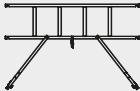

9.

Art.-No.	Art.-No.					kg		
		A	945105	945112	945129		945136	945143
		B	2,90 m	4,30 m	5,30* m		6,30 m	7,30* m
		C	0,90 m	2,30 m	3,30 m		4,30 m	5,30 m
C		2,35 m	3,45 m	4,45 m	5,45 m	6,45 m		
Art.-No.						kg		
915078		2	2	3	4	5	7,7	
915085		0	2	2	2	2	3,9	
911001		1	1	2	2	3	13,0	
911018		1	1	1	2	2	13,0	
912855		1	0	0	0	0	1,2	
912848		0	2	2	2	2	5,0	
914071		0	2	2	2	2	6,5	
914095		0	0	0	4	4	8,0	
913562		0	2	2	2	2	2,2	
913517		0	2	2	2	2	2,8	
914118		4	4	4	4	4	3,8	
914026		4	4	4	4	4	0,6	
704405		4	8	10	12	14	0,1	
910073		0	2	4	4	6	3,3	
912879		1	2	0*	2	0*	1,5	
Σ kg		60,4	113,1	137,8	207,5	210,2		

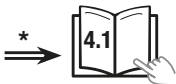

Art.-No.		Art.-No.	945150	945167	945174	945181	945198	kg
		A	8,30 m	9,30* m	10,30 m	11,30* m	12,30 m	
		B	6,30 m	7,30 m	8,30 m	9,30 m	10,30 m	
C	7,50 m	8,50 m	9,50 m	10,50 m	11,50 m			
915078			6	7	8	9	10	7,7
915085			2	2	2	2	2	3,9
911001			3	4	4	5	5	13,0
911018			3	3	4	4	5	13,0
912855			0	0	0	0	0	1,2
912848			2	2	2	2	2	5,0
914071			2	2	2	2	2	6,5
914095			4	4	4	4	4	8,0
913562			2	2	2	2	2	2,2
913517			2	2	2	2	2	2,8
914118			4	4	4	4	4	3,8
914026			4	4	4	4	4	0,6
704405			16	18	20	22	24	0,1
910073			6	8	8	10	10	3,3
912879			2	0*	2	0*	2	1,5
Σ kg			237,9	262,6	287,6	315,0	335,0	

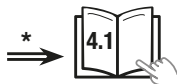

10.

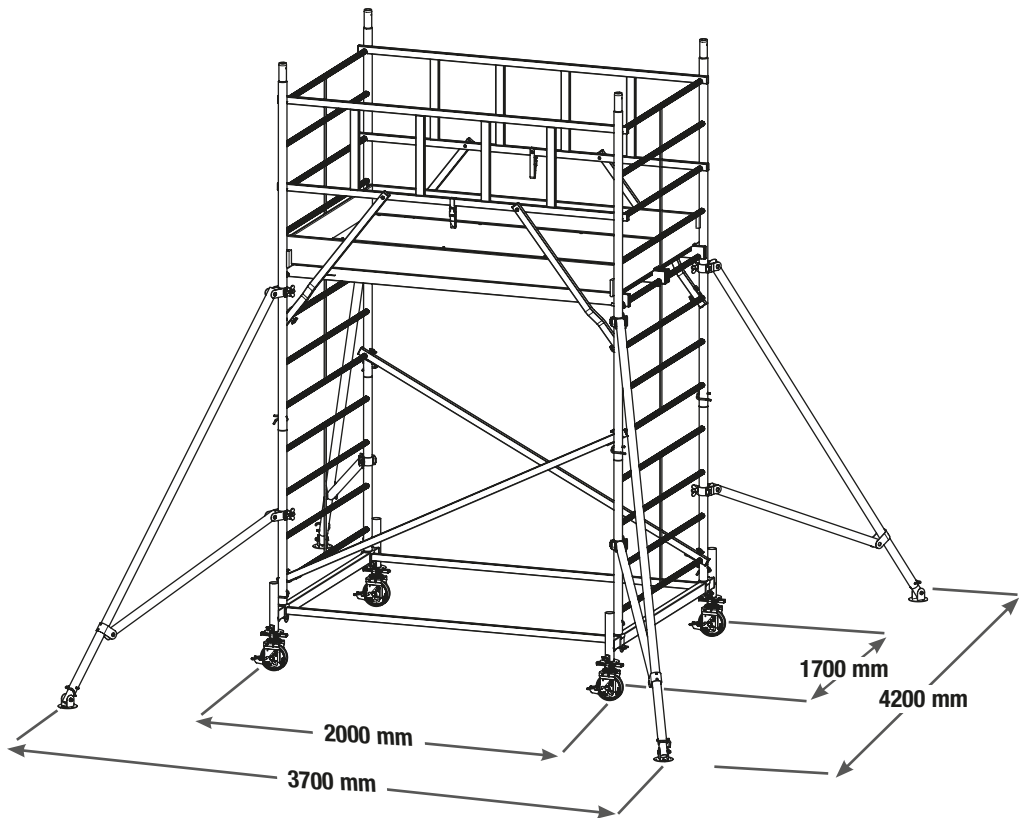

11.

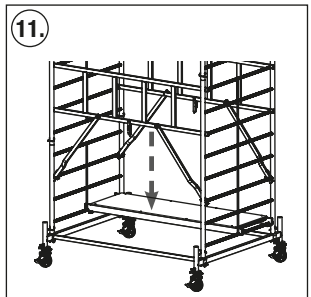
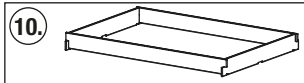
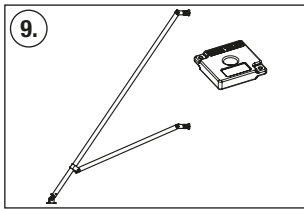
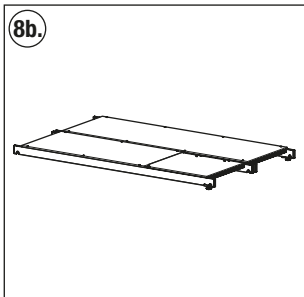
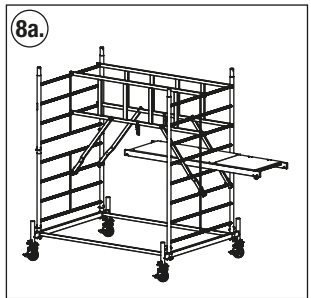
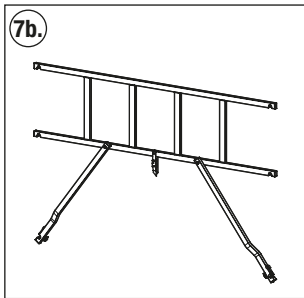
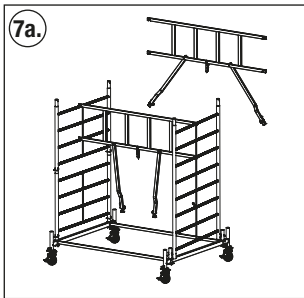
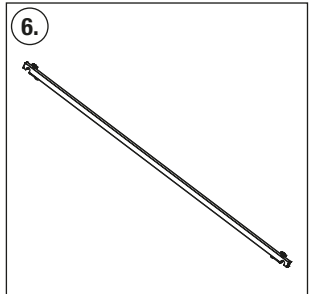
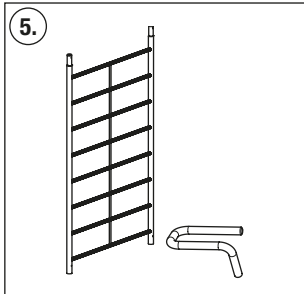
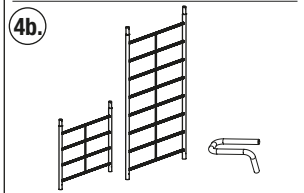
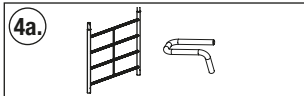
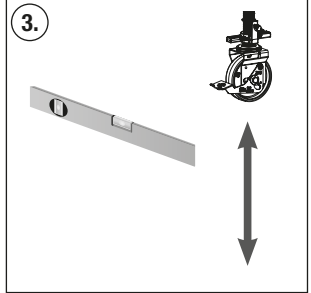
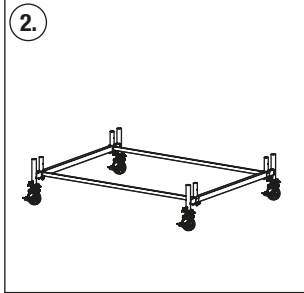
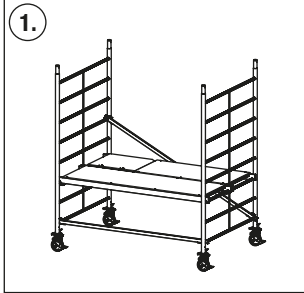

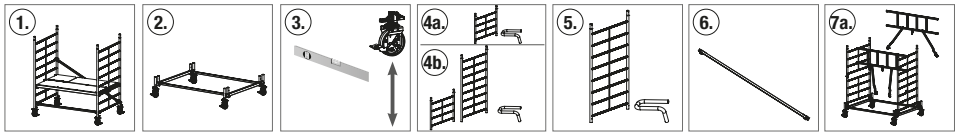

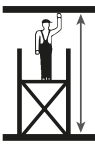
Art.-No.		
945105	3,00 m	= 1.
945112	4,30 m	= 2. + 3. + 4a. + 5. + 6. + 7b. + 8b. + 9. + 10.
945129	5,30 m	= 2. + 3. + 4b. + 5. + 7a. + 8a. + 9. + (5. + 7b. + 8b.) + 10. + 11.
945136	6,30 m	= 2. + 3. + 4a. + 5. + 6. + 7b. + 8b. + 9. + (5. + 7b. + 8b.) + 10.
945143	7,30 m	= 2. + 3. + 4b. + 5. + 7a. + 8a. + 9. + (5. + 7b. + 8b.) + (5. + 7b. + 8b.) + 10. + 11.
945150	8,30 m	= 2. + 3. + 4a. + 5. + 6. + 7b. + 8b. + 9. + (5. + 7b. + 8b.) + (5. + 7b. + 8b.) + 10.
945167	9,30 m	= 2. + 3. + 4b. + 5. + 7a. + 8a. + 9. + (5. + 7b. + 8b.) + (5. + 7b. + 8b.) + (5. + 7b. + 8b.) + 10. + 11.
945174	10,30 m	= 2. + 3. + 4a. + 5. + 6. + 7b. + 8b. + 9. + (5. + 7b. + 8b.) + (5. + 7b. + 8b.) + (5. + 7b. + 8b.) + 10.
945181	11,30 m	= 2. + 3. + 4b. + 5. + 7a. + 8a. + 9. + (5. + 7b. + 8b.) + (5. + 7b. + 8b.) + (5. + 7b. + 8b.) + (5. + 7b. + 8b.) + 10. + 11.
945198	12,30 m	= 2. + 3. + 4a. + 5. + 6. + 7b. + 8b. + 9. + (5. + 7b. + 8b.) + (5. + 7b. + 8b.) + (5. + 7b. + 8b.) + 10.

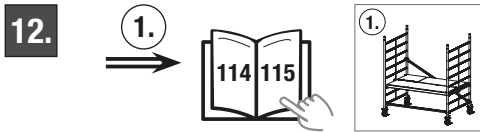

	2 x Art.-No. 915078
	1 x Art.-No. 911001
	1 x Art.-No. 911018
	1 x Art.-No. 912879
	1 x Art.-No. 912855

	4 x Art.-No. 914026
	4 x Art.-No. 914118

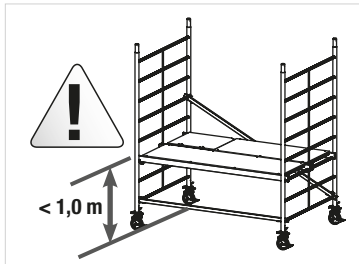
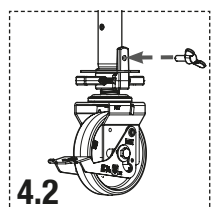
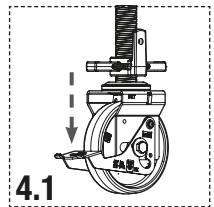
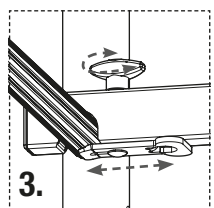
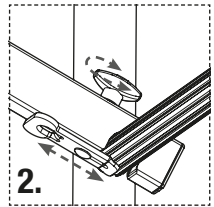
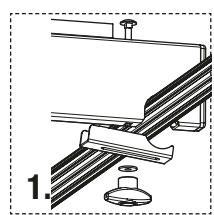
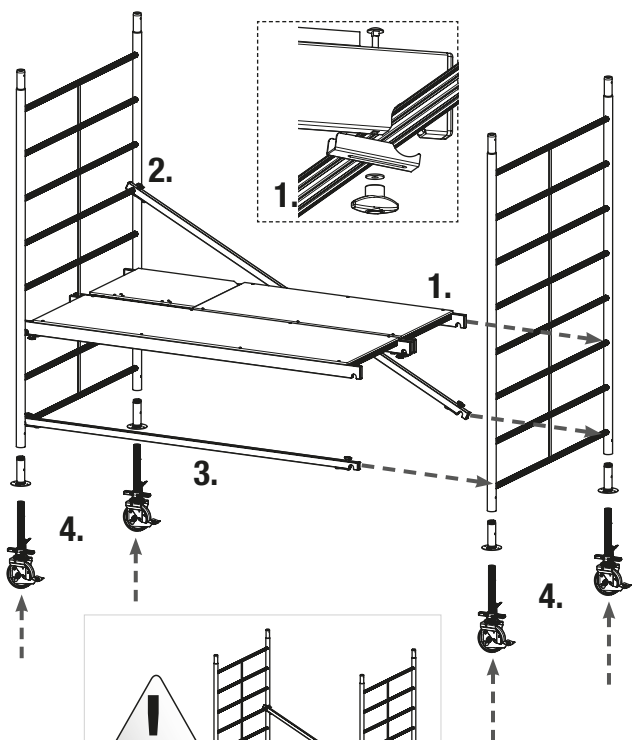

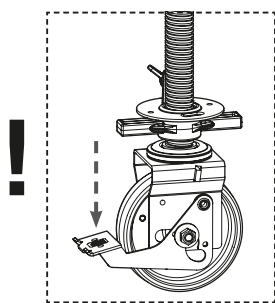
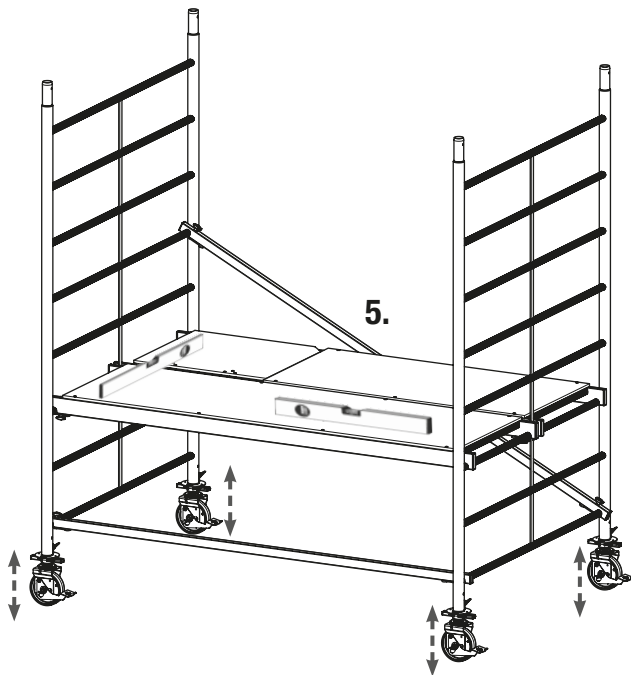

2.

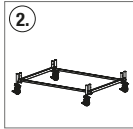

	2 x Art.-No. 912848
	2 x Art.-No. 914071

	4 x Art.-No. 914026
--	---------------------

	4 x Art.-No. 914118
--	---------------------

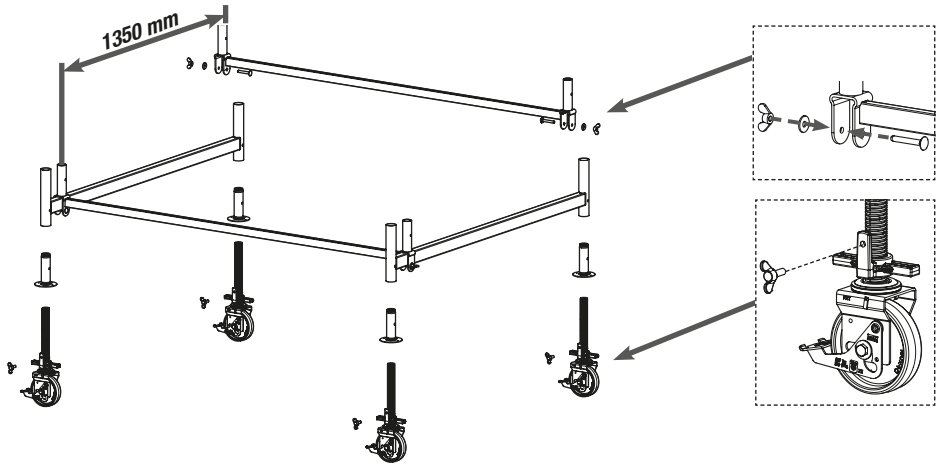

3.

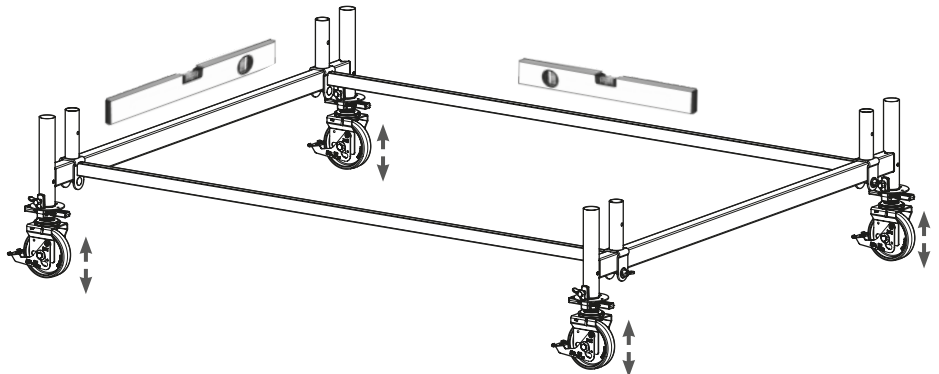
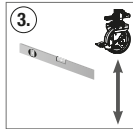



4a.

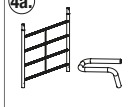

4a.

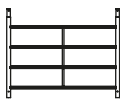

4,30 m, 6,30 m, 8,30 m, 10,30 m, 12,30 m

	<p>2 x Art.-No. 915085</p>
	<p>4 x Art.-No. 704405</p>

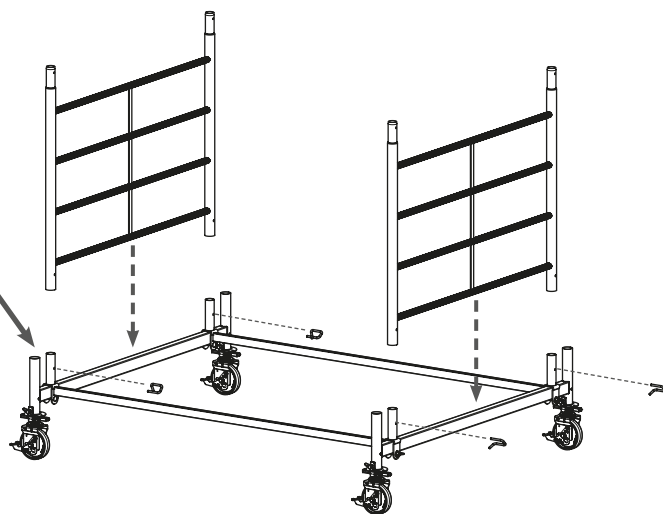
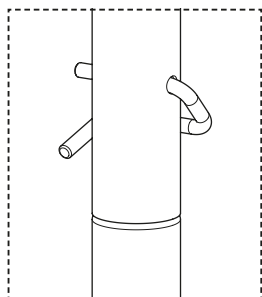

4b.

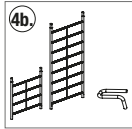

5,30 m; 7,30 m; 9,30 m; 11,30 m

	<p>1 x Art.-No. 915078</p>
	<p>2 x Art.-No. 915085</p>
	<p>6 x Art.-No. 704405</p>

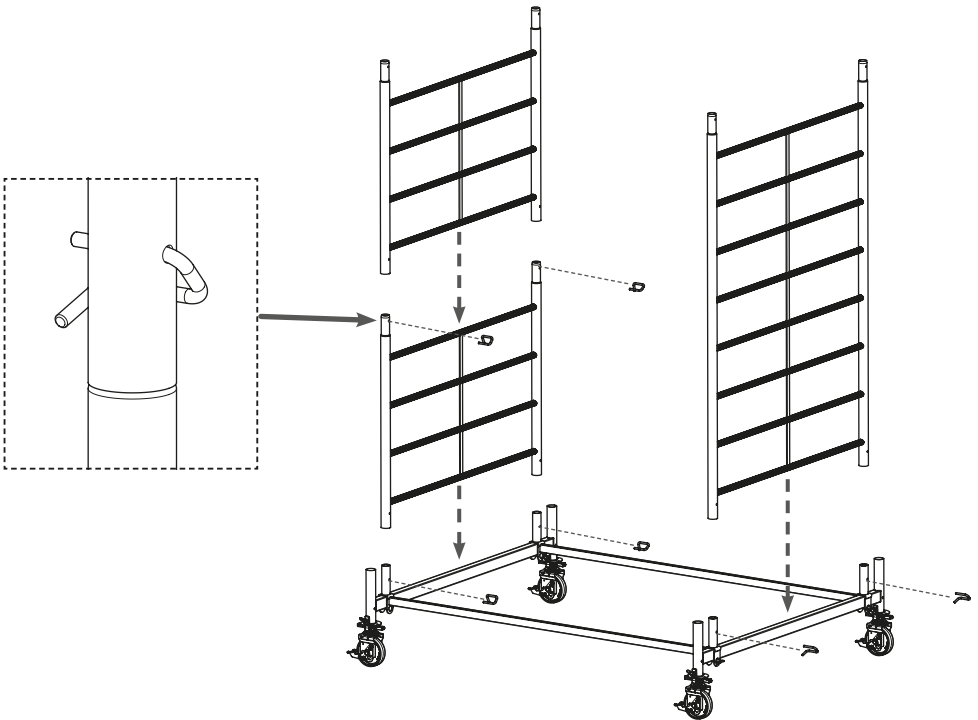

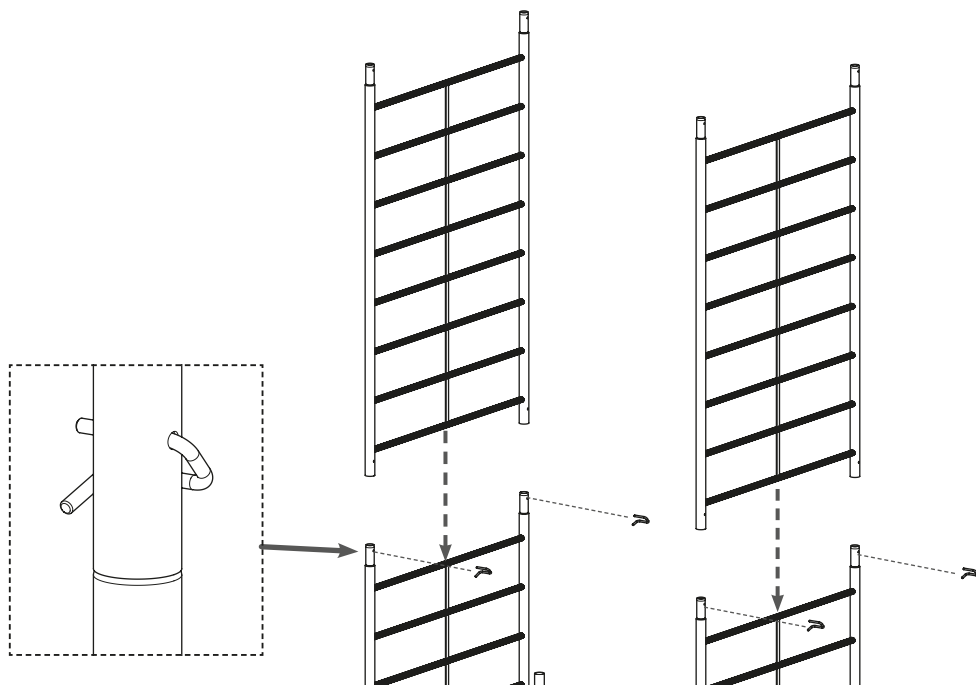
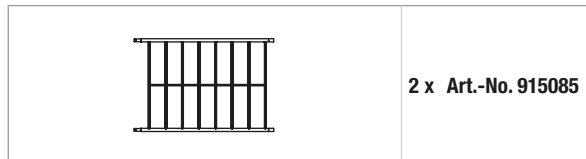
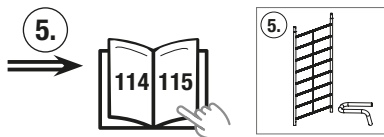

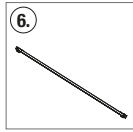
6.
⇒

4,30 m, 6,30 m, 8,30 m, 10,30 m, 12,30 m



2 x Art.-No. 912879

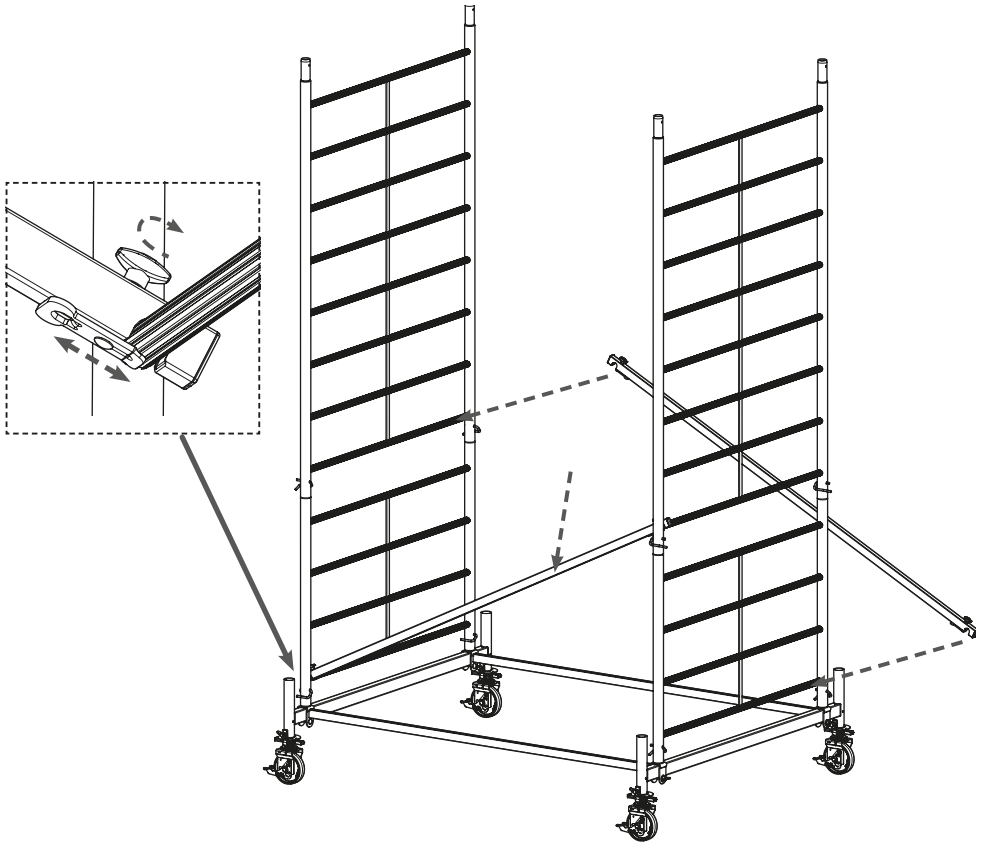

7a.

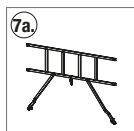

5,30 m, 7,30 m, 9,30 m, 11,30 m

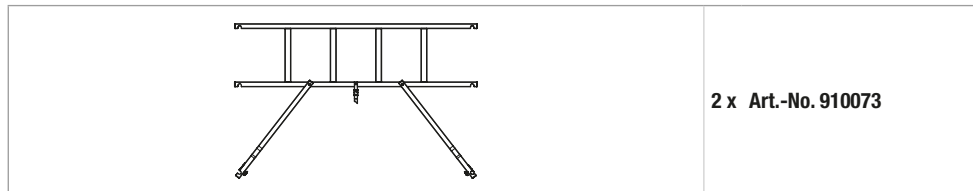

2 x Art.-No. 910073

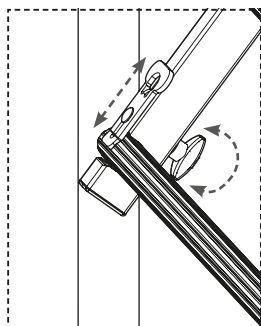
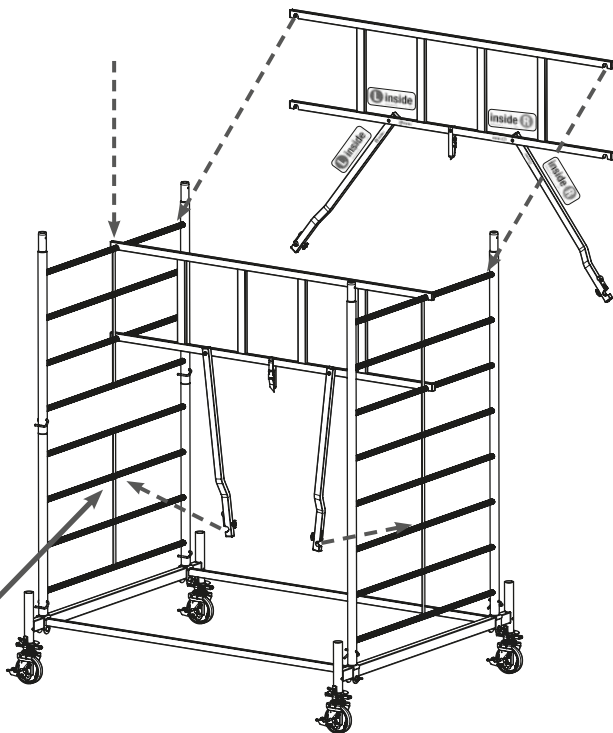
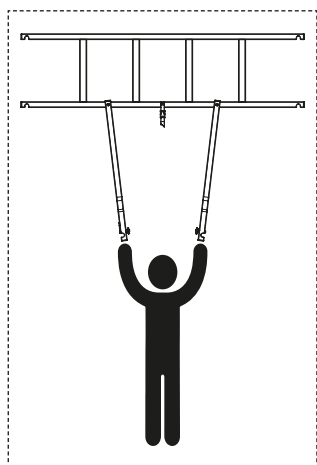

7b.

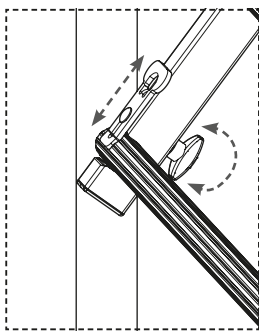
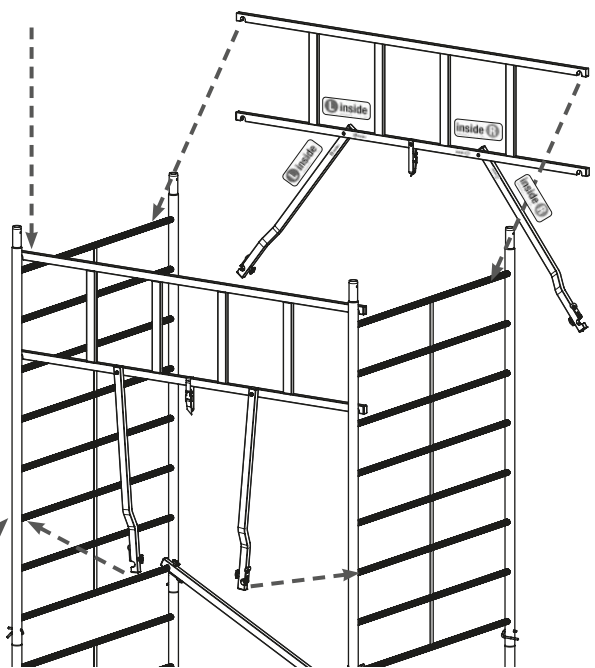
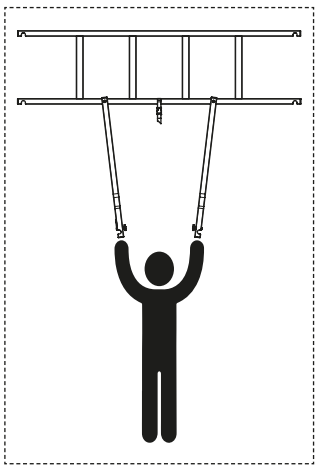
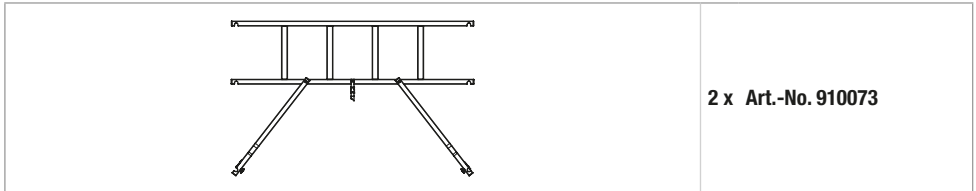

8a.



5,30 m, 7,30 m, 9,30 m, 11,30 m



1 x Art.-No. 911001

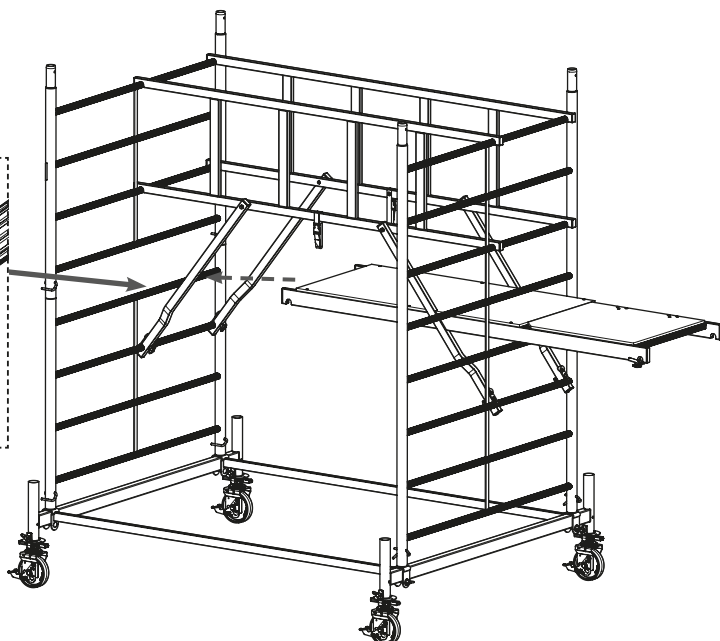
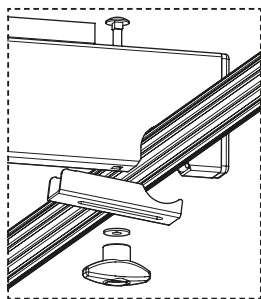

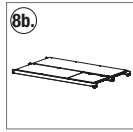
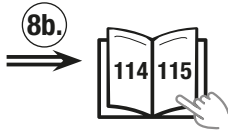

	1 x Art.-No. 911001
	1 x Art.-No. 911018

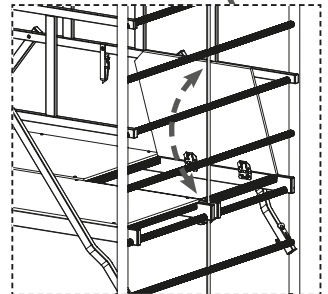
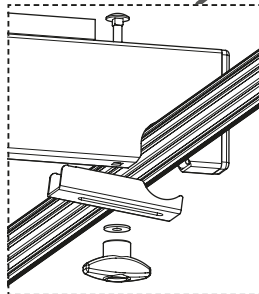
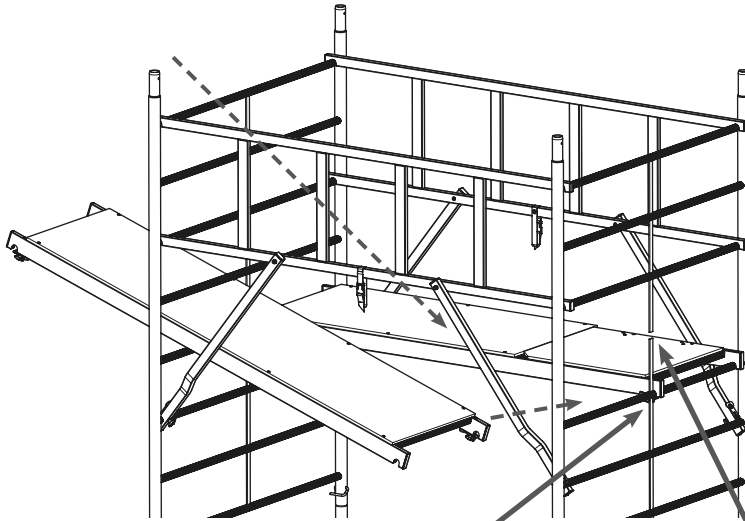

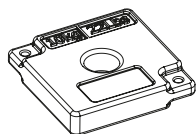
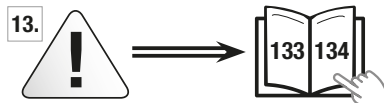
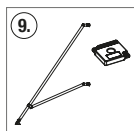
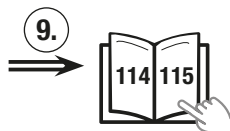

Art.-No. 704306 10 kg

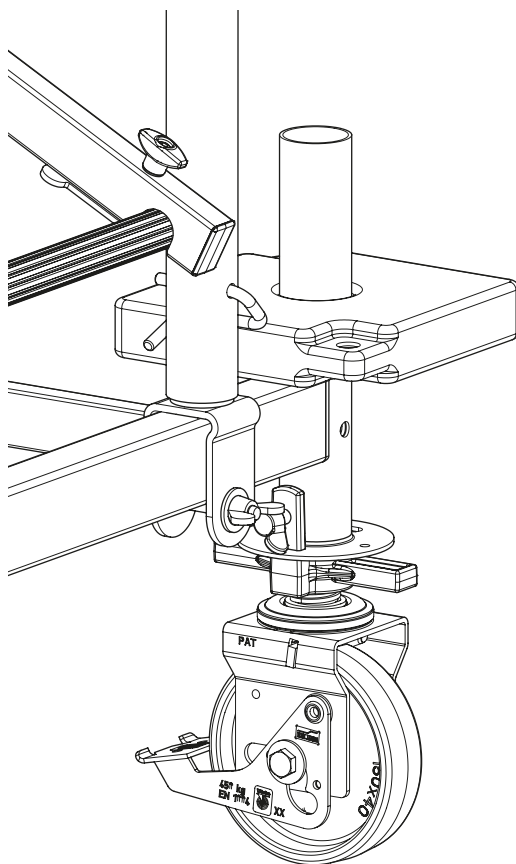

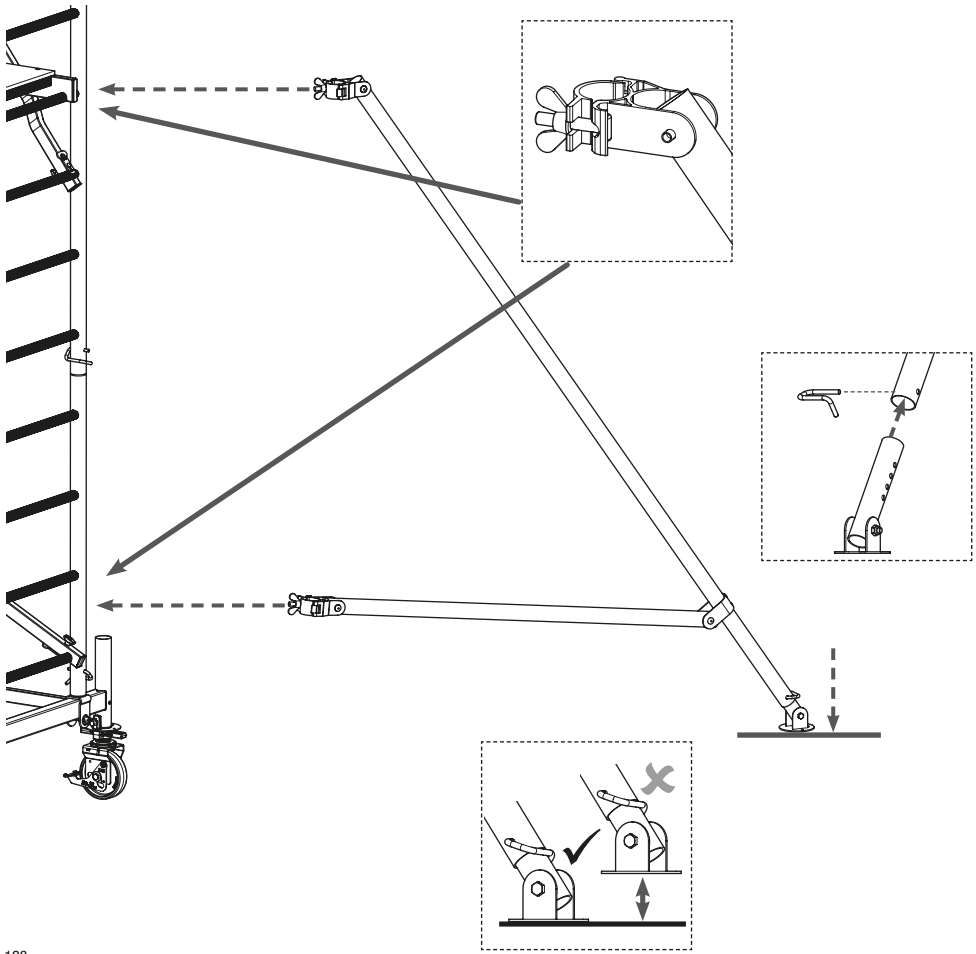
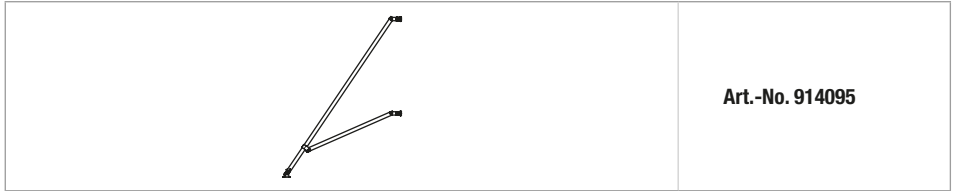
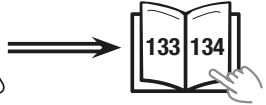
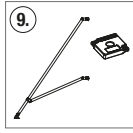
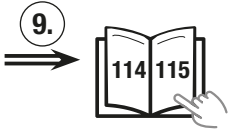



	<p>2 x Art.-No. 913562</p>
	<p>2 x Art.-No. 913517</p>

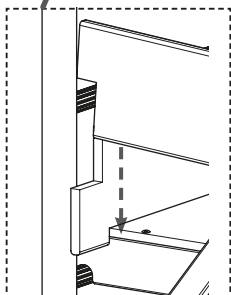
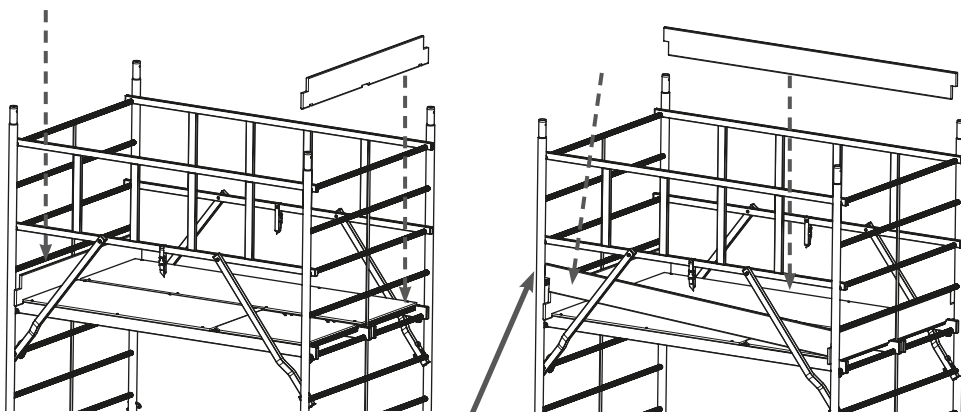



Art.-No. 945112 4,30 m + 4 x Art.-No. 914095

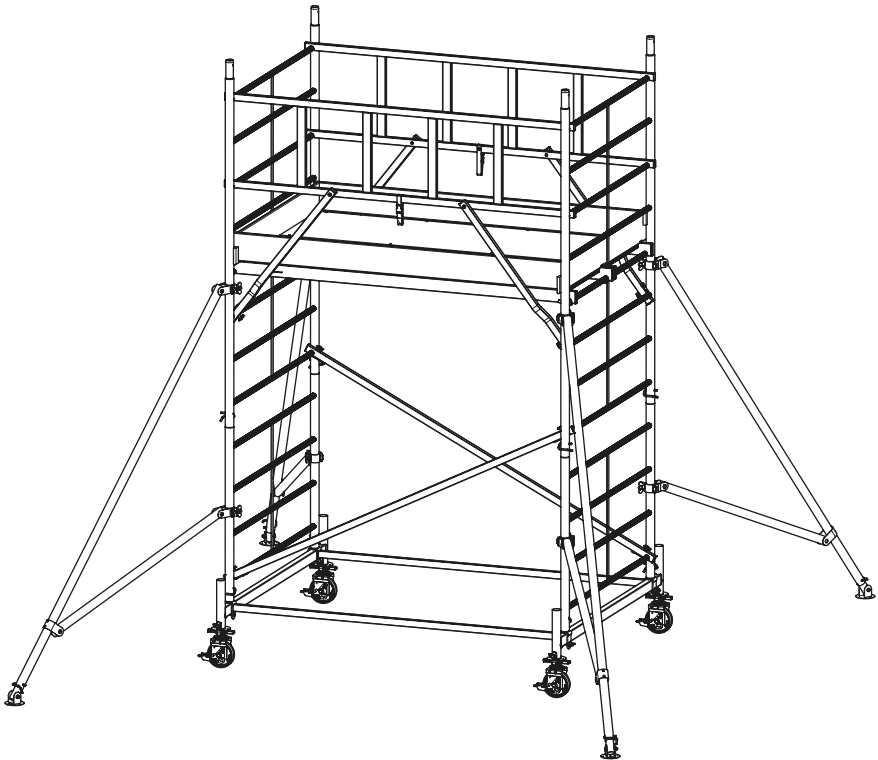

11. →

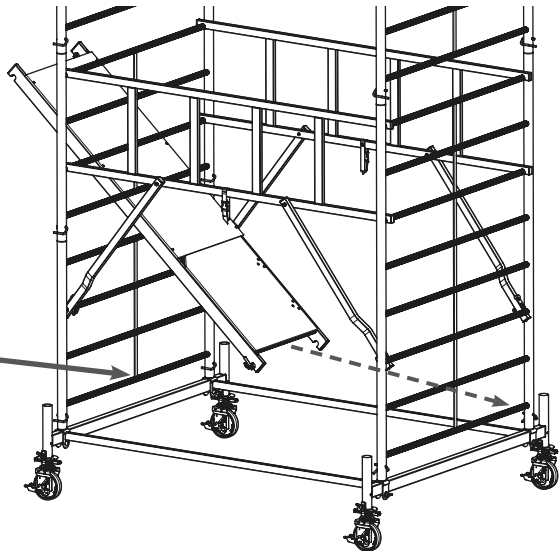
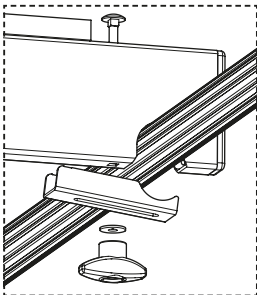
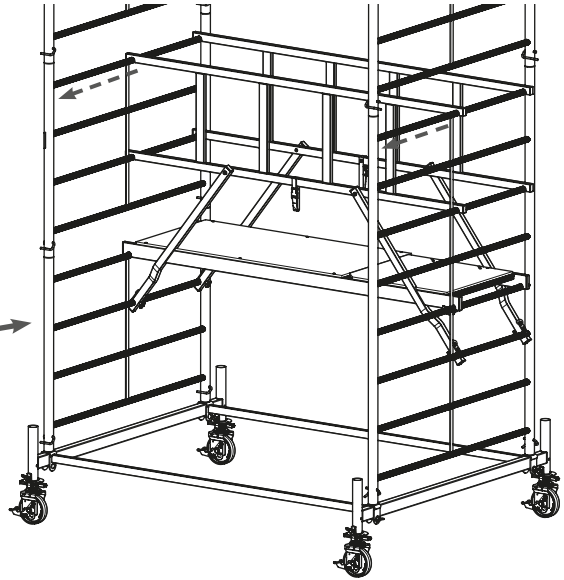
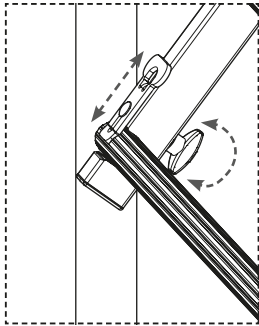









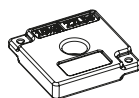
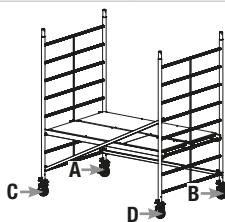
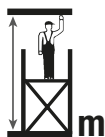
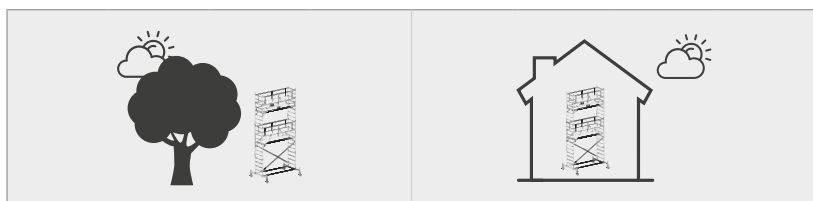
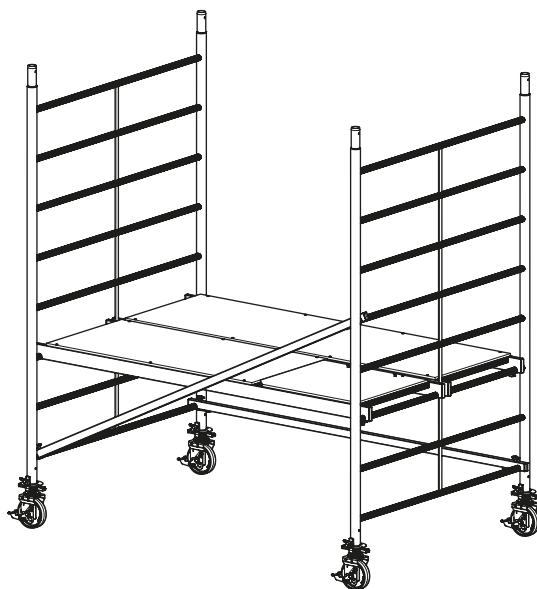



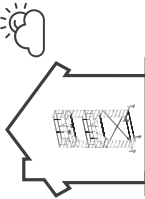
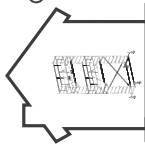





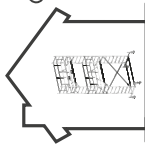

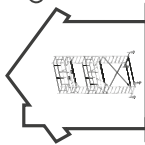

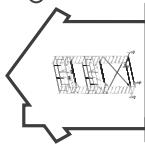

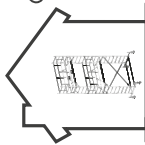

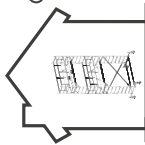

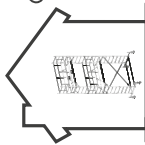

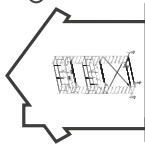

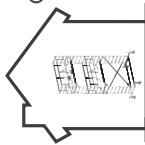

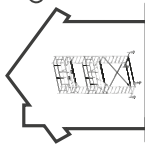

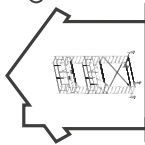

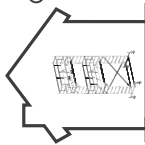

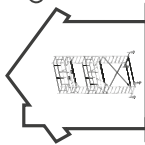

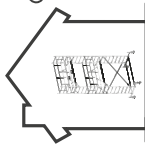

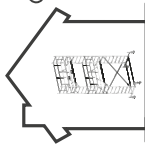

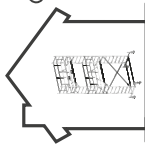

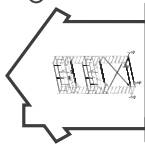

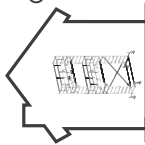

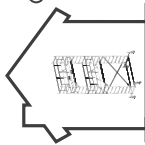

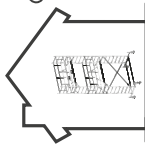

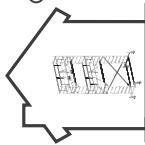

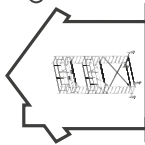

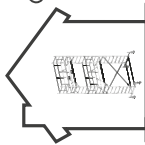

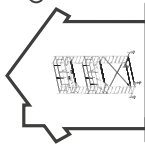

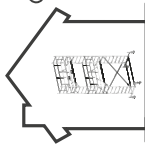

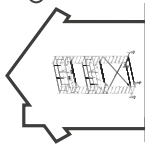

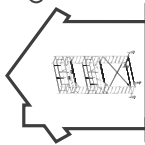

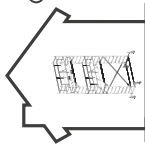

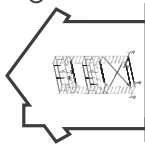

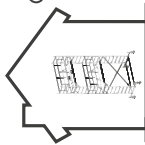

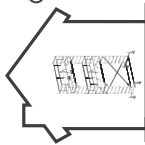

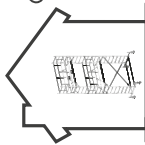

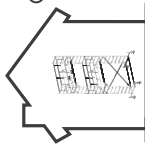

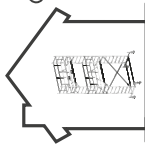

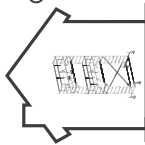

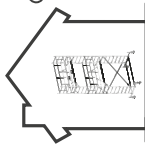

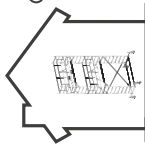

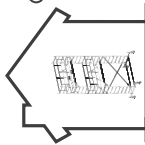

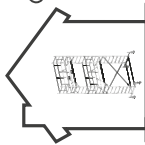

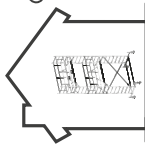

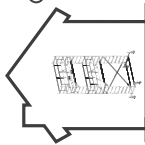

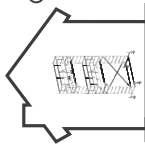

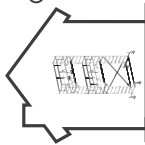

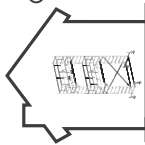

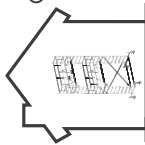

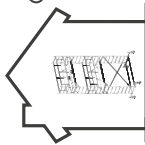

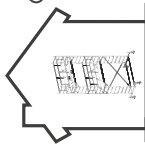

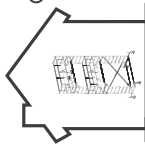

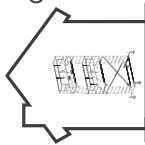

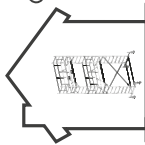

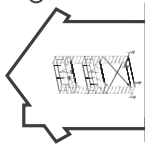

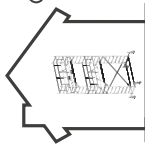

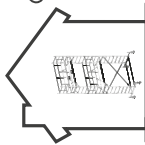

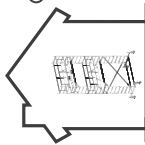

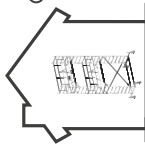

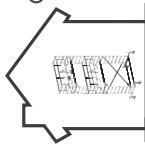

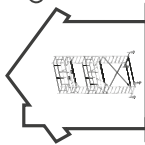

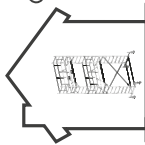

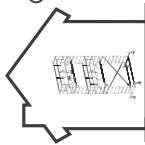

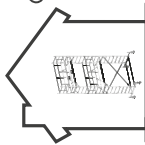

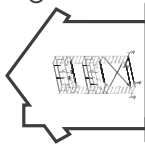

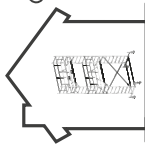

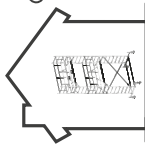

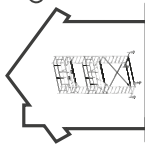

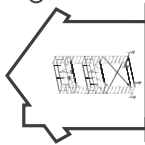

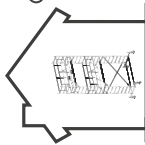

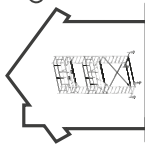

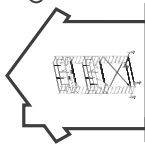

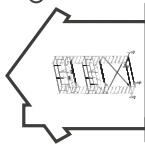

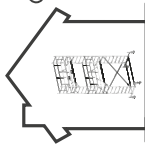

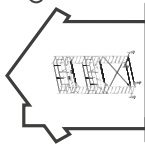

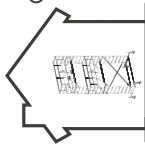

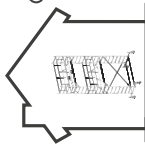

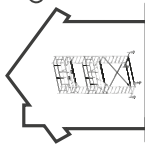

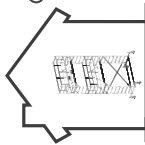

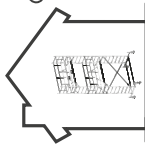

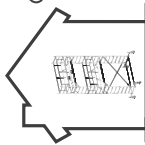

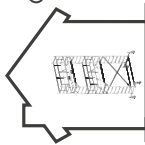

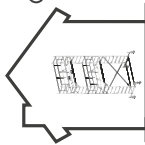

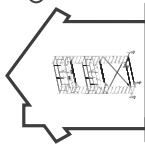

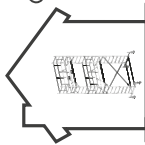

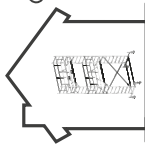

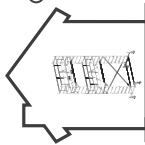

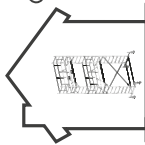

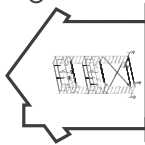

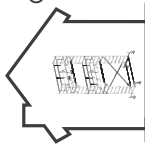

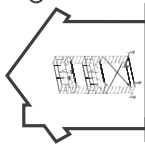

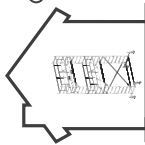
Art.-No. 945129 5,30 m + 4 x Art.-No. 914095

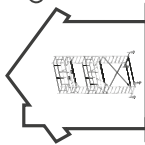

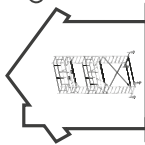
13.

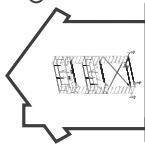

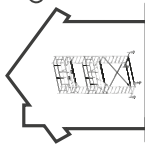



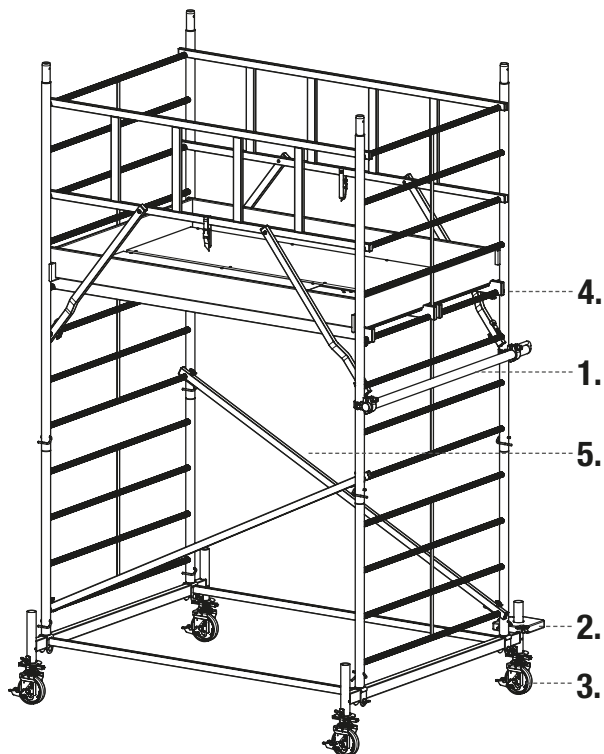

	A	B	C	D	A	B	C	D
< 3,00	0	0	0	0	0	0	0	0

14.

+
Extras



Art.-No.		No.		kg
910066	1,50 m	1		8,4
704306		2		10,0
914118	Ø 150 mm	3		3,8
718853	M5 x 95	4		0,1
912879		5		1,5



Steig- und GerüstSysteme



KRAUSE-Werk GmbH & Co. KG
Am Kreuzweg 3
D-36304 Alsfeld
Tel.: +49 (0) 6631 795-0
Fax: +49 (0) 6631 795-139
E-Mail: info@krause-systems.de



KRAUSE-Systems AG
Chrümble 9
CH-5623 Boswil
Tel.: +41 (0) 56 666 90 50
Fax: +41 (0) 56 666 90 51
E-Mail: info@krause-systems.ch



KRAUSE Kft.
H-2030 Érd
Tolmács u. 7.
Tel.: +36 (06) 23 521 130
Fax: +36 (06) 23 365 109
E-Mail: info@krause-systems.hu



KRAUSE Sp. z o. o.
ul. Stalowa 10
PL - 58- 100 Świdnica
Tel.: +48 (74) 851 88 00
Fax: +48 (74) 851 88 22
E-Mail: info@krause-systems.pl



ООО КРАУЗЕ-СИСТЕМС
RU-129090 Москва
ул. Гиляровского 4, стр. 5, офис 204
тел.: +7 (495) 640 46 56
факс: +7 (495) 640 46 56
E-Mail: info@krause-systems.ru



ТОО „КРАУЗЕ-СИСТЕМС“
KZ-010000, г. Нур-Султан
шоссе Коргалжин 19,
БЦ „Коргалжин“ офис 305 Б
Тел +7 (7172) 57 67 98
E-Mail: info@krause-systems.com.kz

Besuchen Sie uns im Internet:
www.krause-systems.com

